

HYUNDAI
POWER PRODUCTS

ELECTRIC LOG SAW

HSBE2652

ORIGINAL INSTRUCTIONS

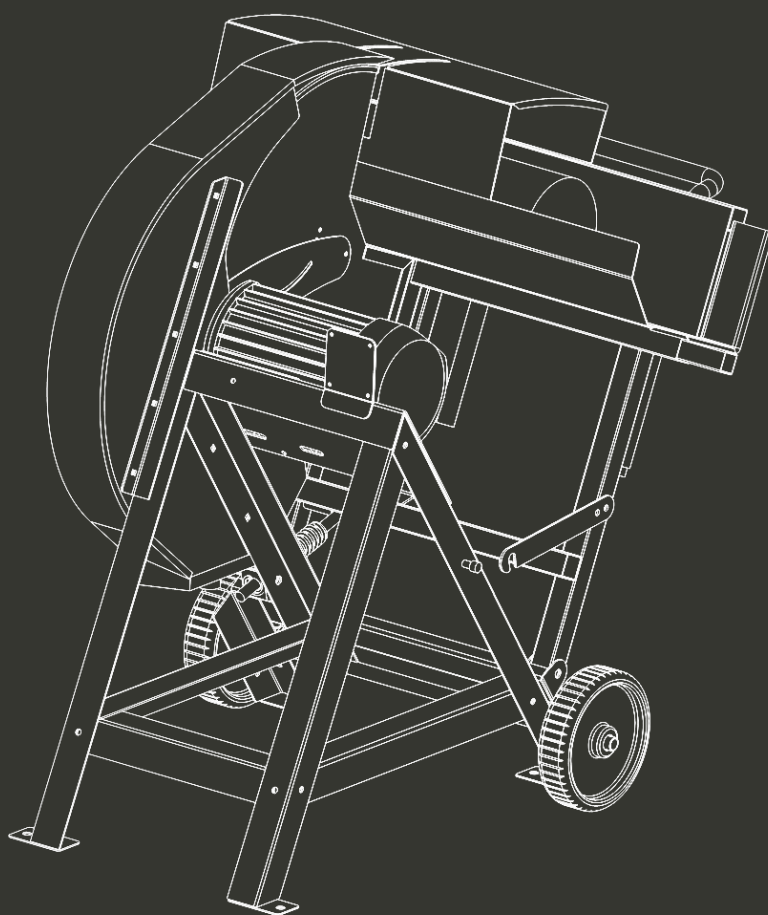

WARNING: Read thoroughly the instruction manual before use.

CONTENTS

1. INTENDED USE.....	3
2. SAFETY INSTRUCTIONS.....	3
3. TECHNICAL SPECIFICATIONS.....	8
4. ASSEMBLY.....	9
5. OPERATION.....	12
6. MAINTENANCE.....	12
7. STORAGE.....	13
8. TROUBLESHOOTING TABLE.....	13
9. DECLARATION OF CONFORMITY.....	14
10. WARRANTY.....	15
11. PRODUCT FAILURE.....	16
12. WARRANTY EXCLUSIONS.....	17

1. INTENDED USE

This machine is only intended for cutting firewood as detailed in these instructions. Unspecified use, modifications to the machine, or use of parts not tested and approved by the equipment manufacturer may cause unforeseeable damage!

This machine is intended for operation by ONE person. Other persons shall keep a sufficient distance to the machine.

2. SAFETY INSTRUCTIONS

2.1 SPECIAL SAFETY WARNINGS

Observe the permissible dimensions of logs to be cut (see “Technical Specifications”).

Never cut several workpieces at the same time – and also no bundles containing several individual pieces. Risk of personal injury if individual pieces are caught by the saw blade uncontrolled. Never cut log containing the following:

- ropes
- cords
- cables
- wires

Do not overload machine – use it only within the performance range it was designed for (see “Technical specifications”).

Use this machine outdoor only.

2.2 GENERAL SAFETY WARNINGS

When using this machine observe the following safety instructions, to exclude the risk of personal injury or material damage.

Please also observe the special safety instructions in the respective chapters; where applicable, follow the legal directives or regulations for the prevention of accidents pertaining to the use of circular saw.



General hazards!

1. Be alert. Know what you are doing. Set out to work with reason. Do not operate machine while under the influence of drugs, alcohol or medication.
2. Keep your work area tidy – a messy work area invites accidents.
3. Regularly clear the work area of the cut logs.
4. Prevent adverse body positions. Ensure firm footing and keep your balance at all times.
5. Consider environmental effects:

Provide proper lighting.

Do not operate machine near inflammable liquids or gases.

This machine shall only be started and operated by a person familiar with circular saw and who is at all times aware of the dangers associated with the use of such machine.

Keep bystanders, particularly children, out of the danger zone. Persons under 18 years of age shall use this machine only in the course of their vocational training, under the supervision of an instructor.

Do not permit other persons to touch the machine or power cable while it is running.

6. During operation the machine is standing on level, horizontal ground and that the floor area around the machine is level, well maintained and free from loose material e.g. chips and off-cuts.
7. Stock and finished workpieces to be located close to the operators normal working position.
8. The wear of suitable personal protective equipment when necessary; This may include:

- Hearing protection to reduce the risk of induced hearing loss;
 - Respiratory protection to reduce the risk of inhalation of harmful dust;
 - Gloves for handling saw blades (saw blades should be carried in a holder wherever practicable).
9. Stop the machine running whilst unattended.
 10. Report faults in the machine, including guards or saw blades, as soon as they are discovered.
 11. Adopt safe procedures for cleaning, maintenance and remove chips and dust regularly to avoid the risk of fire.
 12. Follow manufacturer's instructions for use, adjustment and repair of saw blades.
 13. Observe the maximum speed marked on the saw blade.
 14. To use correctly sharpened saw blades.
 15. Refrain from removing any off-cut or other part of the workpiece from the cutting area whilst the machine is running except by using a push stick.
 16. Use the saw blades designed to reduce the emitted noise.
 17. Ensure that guards and other safety devices necessary for machine operation are in position, in good working order and properly maintained.
 18. The saw blade made in conformity to EN847-1: 2013 shall be used on the machine.
 19. Never dismantle the machine's safety devices or render them inoperative.
 20. To rectify faults or remove jammed pieces of wood, always switch off the machine first. Pull the power plug!
 21. Refit all guards and safety devices immediately after you have completed any repairs or maintenance work.
 22. The circular saw has to be connected to a 230 V socket with a 16 A fuse.
 23. Make sure you stand squarely and keep your balance at all times.
 24. Each time before re-using the tool, carefully check that the guards or parts are working as intended.
 25. Check that the moving parts are in good working order, that they do not jam, and that no parts are damaged. Make sure that all parts are fitted correctly and that all other operating conditions are properly fulfilled.
 26. Have damaged switches replaced by a customer service workshop.
 27. Use only the transport devices to move the machine. Never use the guards for handling and moving the machine.
 28. All operators must receive proper training in the use, adjustment and operation of the machine.
 29. Make sure that the flanges used are as specified by the manufacturer , suitable for the intended use .
 30. Make sure you include that necessary for operating the machine guards and other safety devices are fitted, they are in good operating condition and properly maintained.
 31. Do not use circular saw blades made of high-alloy high-speed steel.



Danger! Risk of electric shock!

To ensure the machine remains weatherproof, before any use check to see that the switch, power cable or plug are not damaged (no cracks, etc.)

Do not use the power cable for any purpose it is not intended for.



Risk of personal injury and crushing by moving parts!

Do not operate the machine without installed guard.

Keep sufficient distance to driven components when operating the machine.

Ensure the machine is disconnected from power supply before servicing.

Ensure that when switching on (e.g. after servicing) no tools or loose parts are left on or in the

machine.

Turn power off if the machine is not used.



Hazard generated by modification of the machine or use of parts not tested and approved by the equipment manufacturer!

Use only parts approved by the equipment manufacturer. This applies particularly to :

- Saw blade (see “Technical specifications”)
- ON/OFF switch (type: KOA7)
- Motor (type: YY90-2-1)

Do not change any parts.



Hazard generated by machine defects!

Keep machine and accessories in good repair. Observe the maintenance instructions.

Before any use check machine for possible damage: before operating the machine all safety devices, protective guards or slightly damaged parts need to be checked for proper function as specified. Checked to see that all moving parts work properly and do not jam. All parts must be correctly installed and meet all conditions necessary for the proper operation of the machine.

Damaged protection devices or parts must be repaired or replaced by a qualified specialist. Have damaged switches replaced by a service center. Do not use this machine if the switch can not be turned ON or OFF.

Keep handles free of oil, grease and resin.



Hazard generated by dust

Pay attention to the factors that influence exposure to dust, this includes:

- Type of material being machined
- Importance of local extraction (capture at source)
- Proper adjustment of hood / baffles / chutes

A The machine should be checked whether inner and outer blade cover, left and right side table moving cover, inner and outer flange of blade and blade are proper before operation.

B Pushing the moving worktable forward and check whether left and right table moving cover and inner and outer blade touch each other so as to avoid unnecessary damage, while the log saw is working after turning-on the power.

C Please turn off the power supply after using, cleaning the machine, save at dry airiness place.

Remove plug from mains before maintenance or if cord is damaged

WARNING! Electricity - Risk of electric shock.

Warning symbol

Use a protection for face

2.3 SAFE WORKING PRACTICE

It is essential all operators are:

- Adequately trained in the use, adjustment and operation of the machine;
- Instructed in factors that influence exposure to noise e.g.:
 - saw blade designed to reduce the emitted noise;
 - saw blade and machine maintenance.
- Informed of factors that influence exposure to dust e.g.:
 - type of material being machined;
 - importance of local extraction(capture at source);
 - proper adjustment of hoods/baffles/chutes;

- where provided, dust extraction equipment to be switched on before commencing machining.

It is important that:

- During operation the machine is standing on level, horizontal ground and that the floor area around the machine is level, well maintained and free from loose material e.g. chips and off-cuts;
- Adequate general or localized lighting is provided;
- Stock and finished workpieces are located close to the operator's normal working position.

It is essential for the operator to:

- Use a push block or push stick to avoid working with the hands close to the saw blade when using a dual purpose circular sawing machine for firewood/circular saw bench in the saw bench mode;
- Wear suitable personal protective equipment when necessary; this could include;
 - hearing protection to reduce the risk of induced hearing loss;
 - respiratory protection to reduce the risk of inhalation of harmful dust;
 - gloves for handling saw blades (saw blades should be carried in a holder wherever practicable);
- Refrain from cross cutting logs on a machine in the saw bench mode;
- Stop the machine running whilst unattended;
- report faults in the machine, including guards or saw blades, as soon as they are discovered;
- Adopt safe procedures for cleaning, maintenance and remove chips and dust regularly to avoid the risk of fire;
- follow manufacturers instruction for use, adjustment and repair of saw blades;
- Select the correct riving knife, depending on the saw blade thickness, when using a dual purpose circular sawing machine for firewood/circular saw bench in the saw bench mode;
- Observe the maximum speed marked on the saw blades;
- Use correctly sharpened saw blades;
- Ensure that any spacers and spindle rings used are suitable for the purpose as stated by the manufacturer;
- refrain from removing any off-cut or other part of the workpiece from the cutting area whilst the machine is running except by using a push stick;
- Ensure that guards and other safety devices necessary machine operation are in position, in good working order and properly maintained.

2.4 RESIDUAL RISK

The following risks are inherent to the use of these machines:

- Injuries caused by touching the rotating parts
- Injuries caused by disruption of the cutting blade

These risks are most evident:

- Within the range of operation
- Within the range of the rotating machine parts









In spite of the application of the relevant safety regulations and the implementation of safety devices, certain residual risks cannot be avoided. These are:



- Impairment of hearing.
- Risk of accidents caused by the uncovered parts of the rotating cutting blade.
- Risk of injury when changing the blade.
- Risk of squeezing fingers when opening the guards.

- Braking should be verified every before use, running the machine, switch off then check the stopping time.
- Only saw blades made in conformity to EN 847-1:1997 shall be used on the machine;
- The machine during indoor use shall be connected to an external chip and dust extraction system;
- A Residual Current Device (RCD) should be used

2.5 DESCRIPTION OF THE SYMBOLS

The use of symbols in this manual is intended to draw your attention to possible risks. The safety symbols and the explanations that accompany them must be perfectly understood. The warnings in themselves do not remove the risks and cannot replace correct actions for preventing accidents.

	<p>Read the operator's manual. Before any use, refer to the corresponding paragraph in the present manual.</p>
	<p>This symbol, before a safety comment, indicates a precaution, a warning or a danger. Ignoring this warning can lead to an accident for yourself or for others. To limit the risk of injury, fire, or electrocution always apply the recommendations indicated.</p>
	<p>Risk of electric shock! Risk of personal injury by electric shock.</p>
	<p>Wear ear protection, eye protection, helmet, mask, non-skid footwear, gloves and face protection</p>
	<p>Saw blade for cutting wood.</p>
	<p>Do not use for face grinding.</p>
	<p>Do not use in the rain or leave outdoors while it's raining.</p>
	<p>Always switch off the appliance, disconnect the power and wait till the machine comes to a standstill prior to maintenance, cleaning or repair work!</p>
	<p>Keep children away.</p>

	<p>The unit must be always operated by one person only. Other people should keep a safe distance from the work area, especially when the log saw is under operations. Never use another people to help you with freeing jammed log.</p>
	<p>Conforms to European standards.</p>
	<p>The crossed-out wheeled bin symbol indicates that the item should be disposed of separately from household waste. The item should be handed in for recycling in accordance with local environmental regulations for waste disposal. By separating a marked item from household waste, you will help reduce the volume of waste sent to incinerators or land-fill and minimize any potential negative impact on human health and the environment.</p>

3. TECHNICAL SPECIFICATIONS

Voltage	230V~ 50Hz
Protection class	IP54
Power input	2600W (S6, 40%)
Rated speed	2800 min ⁻¹
Saw blade	Ø505 × Ø30 × 3.6mm x 40T
Cutter Capacity	Ø30-170mm
Machine weight	76kg
Sound pressure level LpA:	91 dB(A) K=2 dB(A)
Sound power level LwA:	105 dB(A) K=2 dB(A)

Measured sound values determined according to EN ISO 3744

The noise figures quoted are emission levels and are not necessarily safe working levels. Whilst there is a correlation between the emission and exposure levels, this cannot be used reliably to determine whether or not further precautions are required. Factors that influence the actual level of exposure of work-force include the characteristics of the work room, the other sources of noise, etc. i.e. the number of machines and other adjacent processes, and the length of time for which an operator is exposed to the noise. Also the permissible exposure level can vary from country. This information, however, will enable the user of the machine to make a better evaluation of the hazard and risk.

Wear hearing protection!

Pay attention to the factors that influence exposure to noise, this includes:

- Use saws blades designed to reduce the emitted noise
- Maintain saw blade and the machine properly

4. ASSEMBLY

1. Open package and take out all parts. (see picture 1)

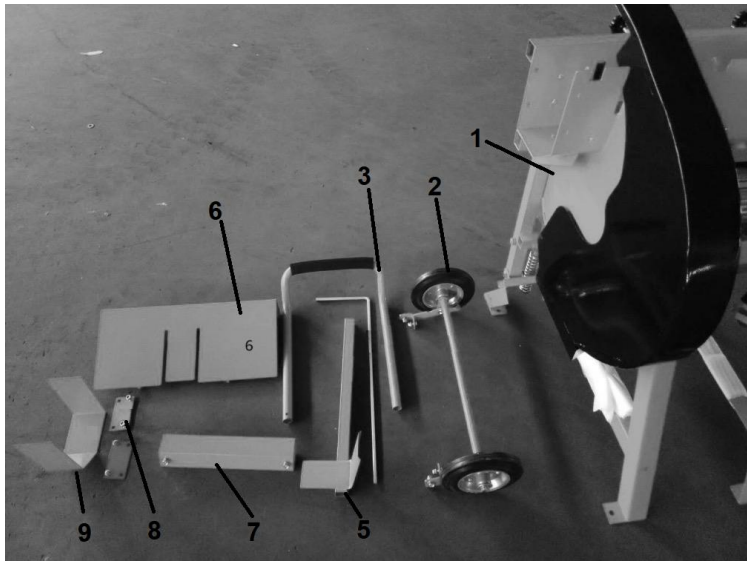

Picture 1

- 1. Main machine
- 2. Wheel parts
- 3. operating handle
- 4. ruler bar
- 5. wood supporter
- 6. cover for working table
- 7. weight balancer
- 8. connect plate for working table
- 9. working table

2. Disassemble the spring pipe (see picture 2) to put it into the right fixer, screw it with M18 anti-loose nut (see picture 4). Place the pedal in the guide and tighten the nut, also tighten the pedal axle nut(see picture 5).



Picture 2

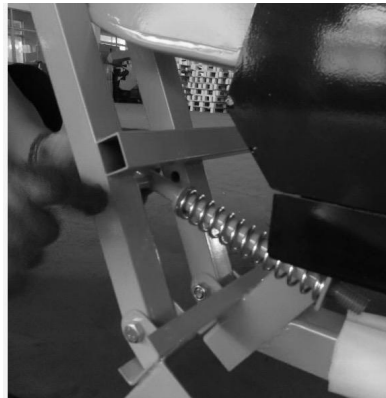

Picture 3



Picture 4



Before



After

Picture 5

3. Assemble the wheel parts. Firstly disassemble all screws and nuts on it. Then connect it with the frame and tighten all screws and nuts (see picture 6 and picture 7). Position the wheel kit under the machine and screw the 4 bolts, nuts and washers into their places(see picture 8).



Picture 6



Picture 7



Picture 8

4. Assemble the vice working table. Firstly use four M8X15 large semicircular head square neck bolts to assemble the connect plate for vice working table on main working table , secondly use four M8X15 large semicircular head square neck bolts to assemble vice working table on connect plate (see picture 9 and picture 10).



Picture 9



Picture 10

5. Assemble the working table cover. Insert the rotating block on cover into the corresponding fixing block on working table and fix it with M4x8 cross countersunk head screw (see picture 11).



Picture 11

6. Assemble the operating handle.

Put it into the right holes on working table and Screw on the 2 knobs after sliding the 2 tubes of the carrying handle (2 positions with notches: high and low).(see picture 12).

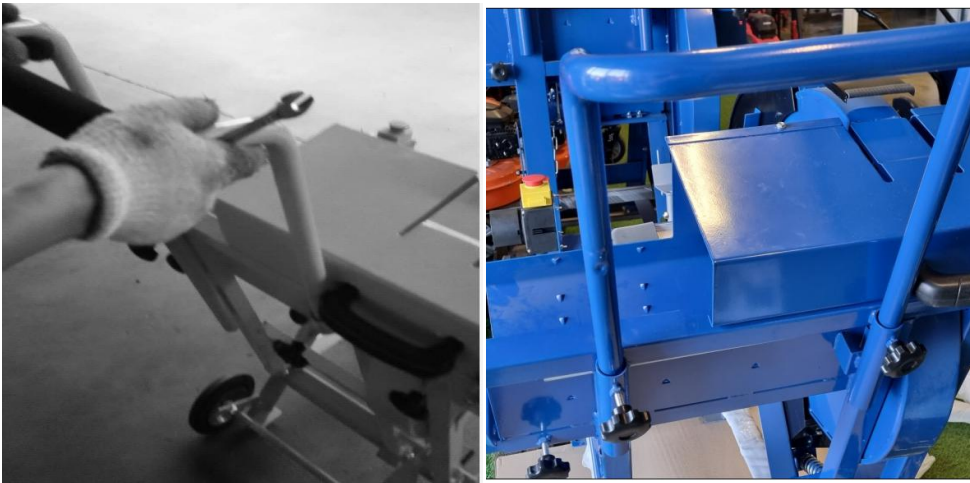

Picture 12

7. Assemble the wood supporter and ruler bar, put them into corresponding holes(see picture 13 and picture 14).



Picture 13



picture 14

8. Position the flyweight in its place and screw on the 2 nuts(see picture 15).



Picture 15

5. OPERATION

5.1 SAWING

1. Open the machine by removing the safety bar at the bottom of the machine.
2. Turn on the machine.
3. Wait until the saw blade has reached its maximum speed.
4. Place the wood on the rocker by using the pusher.
5. Grasp the balance handlebar with both hands and push it towards the blade.
6. Push the rocker with evenly so that the engine speed does not drop.
7. Remove the sawn wood from the scale before installing the next piece.
8. When finished, turn off the machine and wait for the blade to stop completely. Put back the safety bar.

5.2 SAFE REMOVAL OF POSSIBLE BLOCKING

Unplug the machine.

Check it and localize the blocking.

Remove the blocking while considering all safety instructions.

Check the machine visually and make sure it is not damaged. In particular, the saw blade must not show any sign of damage.

6. MAINTENANCE

- **Warning:** Turn off the machine and disconnect from the power supply before conducting maintenance work or settings.
- Wear goggles when cleaning the machine.
- Handle your device carefully and out of reach of the children.
- Have your tool repaired by a qualified person. This power tool complies with the applicable safety standards. Repairs should be performed only by qualified persons using original spare parts, otherwise this may make the use extremely dangerous.
- Use only the blade recommended by the manufacturer for this model. If a blade is damaged, it must only be repaired by the manufacturer or qualified persons.
- Use only well-sharpened, crack-free and not distorted blades.
- Use only blades that comply with the European standard EN 847-1.

- Ensure that there are no tools or other materials on or in the machine before putting it into operation.
- Exchange immediately rocker that run out.

6.1 BEFORE AND AFTER EACH USE

- Check the blade
- Make the air vents are never obstructed by debris or accumulation of other objects, as this may damage the engine or cause a fire risk.
- Clean your tool, using a damp cloth and a soft brush. Never clean the product with water and never immerse it in liquid. Never use solvents or detergents as this may damage the plastic parts of the product.
- Check all safety
- Remove possible sawdust blockages at the discharge.

6.2 EVERY 50 HOURS OF OPERATION

- Check all screwed connections, tighten if necessary (Rocker and rocker stop must remain movable)

7. STORAGE

- Store the manual close to the machine.
- Always wait the appliance cool down before storage.
- Always store the log saw in a dry area.
- Wipe the log saw clean with a brush. Apply a thin layer of oil using an oily cloth to protect the machine from rust, before storage.

8. TROUBLESHOOTING TABLE

Warning: In the interests of operational safety, always switch off the saw and remove the mains plug before carrying out maintenance work.

Problem	Possible Cause	Help
Saw blade gets loose after turning off the motor	Fastening nut tightened insufficiently	Tighten fastening nut, M20 left-handed thread
Motor does not start	a) Failure mains fuse b) Extension cable defect c) Connections on the motor or switch defect d) Motor or switch defect	a) Check the mains fuse. b) Replace extension cord c) Have a mechanic check by a professional d) Have a mechanic by a professional
No motor output turns off automatically	Overload by dull saw blade, thermo protection is triggered	Insert a sharpened saw blade; motor can be turned on again after the cooling period
Burns on the cutting surface	a) Fastening nut tightened insufficiently b) Wrong saw blade	a) Insert a sharpened saw blade b) Insert saw blade with 20 or 28 teeth for longitudinal cuts

9. DECLARATION OF CONFORMITY



EC Conformity declaration

BUILDER SAS

ZI, 32 rue Aristide Bergès – 31270 Cugnaux - France

Tel: +33 (0)5.34.502.502 Fax: +33 (0)5.34.502.503

The undersigned, hereby certifies that the units described below

ELECTRIC LOG SAW

Model: HSBE2652

S/N: 20230310608-20230310679

is in compliance with the provisions of the following European directives:

2014/30/EU " Electromagnetic Compatibility "

2006/42/EC "Machinery"

(EU)2015/863 amending 2011/65/EU "ROHS"

And to the following standards:

EN55014-1: 2017/A11:2020; EN IEC55014-1: 2021

EN55014-2 :1997/A2:2008; EN IEC55014-2: 2021

EN61000-3-2: 2014; EN IEC61000-3-2: 2019/A1:2021

EN61000-3-11: 2000

EN 1870-6: 2017

EN 60204-1: 2018

EC-type certificate number: **No. M6A 058058 0434**

Notified Body: No 0123

TÜV SÜD Product Service GmbH · Zertifizierstelle · Ridlerstraße 65 · 80339 München · Germany

The people name holding the technical file: Mr. Olivier Patriarca

Cugnaux, 01/01/2023

Philippe MARIE / PDG

10. WARRANTY

HYUNDAI

WARRANTY

The manufacturer guarantees the product against defects in material and workmanship for a period of 2 years from the date of the original purchase. The warranty only applies if the product is for household use. The warranty does not cover breakdowns due to normal wear and tear.

The manufacturer agrees to replace parts identified as defective by the designated distributor. The manufacturer does not accept responsibility for the replacement of the machine, in whole or in part, and/or ensuing damage.

The warranty does not cover breakdowns due to:

- insufficient maintenance.
- abnormal assembly, adjustment or operations of the product.
- parts subject to normal wear and tear.

The warranty does not extend to:

- shipping and packaging costs.
- using the tool for a purpose other than that for which it was designed.
- the use and maintenance of the machine done in a manner not described in the user manual.

Due to our policy of continuous product improvement, we reserve the right to alter or change specifications without notice. Consequently, the product may be different from the information contained therein, but a modification will be undertaken without notice if it is recognized as an improvement of the preceding characteristic.

READ THE MANUAL CAREFULLY BEFORE USING THE MACHINE.

When ordering spare parts, please indicate the part number or code, you can find this in the spare parts list in this manual. Keep the purchase receipt; without it, the warranty is invalid. To help you with your product, we invite you to contact us by phone or via our website:

- **+33 (0)9.70.75.30.30**
- **<https://services.swap-europe.com/contact>**

You must create a "ticket" via the web platform.

- Register or create your account.
- Indicate the reference of the tool.
- Choose the subject of your request.
- Describe your problem.
- Attach these files: invoice or sales receipt, photo of the identification plate (serial number), photo of the part you need (for example: pins on the transformer plug which are broken).



11. PRODUCT FAILURE

WHAT TO DO IF MY MACHINE BREAKS DOWN?

If you bought your product in a store:

- a) Empty the fuel tank if your product has one.
- b) Make sure that your machine is complete with all accessories supplied, and clean! If this is not the case, the repairer will refuse the machine.

Go to the store with the complete machine and with the receipt or invoice.

If you bought your product on a website:

- a) Empty the fuel tank if your product has one..
- b) Make sure that your machine is complete with all accessories supplied, and clean! If this is not the case, the repairer will refuse the machine.
- c) Create a SWAP-Europe service ticket on the site: <https://services.swap-europe.com> When making the request on SWAP-Europe, you must attach the invoice and the photo of the nameplate (serial number).
- d) Contact the repair station to make sure it is available before dropping off the machine.

Go to the repair station with the complete machine packed, accompanied by the purchase invoice and the station support sheet downloadable after the service request is completed on the SWAP-Europe site

For machines with engine failure from manufacturers BRIGGS & STRATTON, HONDA and RATO, please refer to the following instructions.

Repairs will be done by approved engine manufacturers of these manufacturers, see their site:

- <http://www.briggsandstratton.com/eu/fr>
- <http://www.honda-engines-eu.com/fr/service-network-page;jsessionid=5EE8456CF39CD572AA2AEEDFD290CDAE>
- <https://www.rato-europe.com/it/service-network>

Please keep your original packaging to allow for after-sales service returns or pack your machine with a similar cardboard box of the same dimensions.

For any question concerning our after-sales service you can make a request on our website <https://services.swap-europe.com>

Our hotline remains available at +33 (9) 70 75 30 30.



12. WARRANTY EXCLUSIONS

THE WARRANTY DOES NOT COVER:

- Start-up and setting up of the product.
- Damage resulting from normal wear and tear of the product.
- Damage resulting from improper use of the product.
- Damage resulting from assembly or start-up not in accordance with the user manual.
- Breakdowns related to carburetion beyond 90 days and fouling of carburetors.
- Periodic and standard maintenance events.
- Actions of modification and dismantling that directly void the warranty.
- Products whose original authentication marking (brand, serial number) has been degraded, altered or withdrawn.
- Replacement of consumables.
- The use of non-original parts.
- Breakage of parts following impacts or projections.
- Accessories breakdowns.
- Defects and their consequences linked to any external cause.
- Loss of components and loss due to insufficient screwing.
- Cutting components and any damage related to the loosening of parts.
- Overload or overheating.
- Poor power supply quality: faulty voltage, voltage error, etc.
- Damages resulting from the deprivation of enjoyment of the product during the time necessary for repairs and more generally the costs related to the immobilization of the product.
- The costs of a second opinion established by a third party following an estimate by a SWAP-Europe repair station
- The use of a product which would show a defect or a breakage which was not the subject of an immediate report and/or repair with the services of SWAP-Europe.
- Deterioration linked to transport and storage*.
- Launchers beyond 90 days.
- Oil, petrol, grease.
- Damages related to the use of non-compliant fuels or lubricants.

* In accordance with transport legislation, damage related to transport must be declared to carriers within 48 hours maximum after observation by registered letter with acknowledgement of receipt.

This document is a supplement to your notice, a non-exhaustive list.

Attention: all orders must be checked in the presence of the delivery person. In case of refusal by the delivery person, it you must simply refuse the delivery and notify your refusal.

Reminder: the reserves do not exclude the notification by registered letter with acknowledgement within 72 hours.

Information: Thermal devices must be wintered each season (service available on the SWAP-Europe site). Batteries must be charged before being stored.

HYUNDAI

POWER PRODUCTS

For Inquiries, please contact:

BUILDER SAS
32, Rue Aristide Bergès Z1 31270 Cugnaux, France
Tél.: +33(0)5.34.502.502 Fax : +33(0)5.34.502.503
<http://www.hyundaipower-fr.com/>
Fabriqué en République Populaire de Chine(PRC)